



SUPER
HANG-ON™

INSTRUCTION MANUAL

Loading Instructions: Starting Up

1. Make sure the power switch is OFF.
2. Insert the Super Hang-On™ cartridge into the Genesis System (shown below) by following instructions in your GENESIS SYSTEM manual.
3. Turn the power switch ON. If nothing appears on the screen, recheck insertion.

IMPORTANT: Always make sure that the System is turned OFF when inserting or removing your Genesis Cartridge.

For 1 Player: Press Start Button on Genesis Control Pad 1.

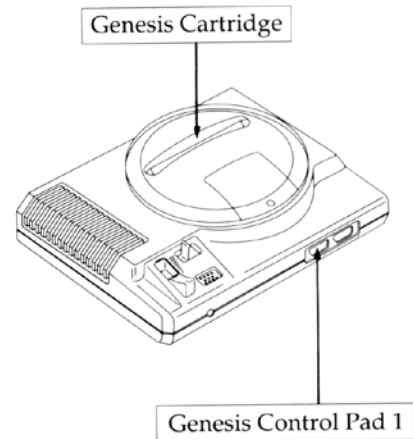

Super Hang-On

Blue light and you're off to a series of the most exhilarating races found the world over. And the best part is, you get to choose your course and set your pace. The bad part is, if you can't keep up with the pack, the game's over. So set your sights on victory, but keep your eyes on the road. One moment of unfocused concentration could end up in sheer desperation. 'Cause when these bikes go down, it's hard getting up.

So take a look at your options and go for the style of play which suits you best. There's the arcade version of Super Hang-On for the masters and now there's a Genesis original: the circuit race. During the circuit race, you'll race against an opponent aided by a trusted mechanic and generous sponsor. Your mechanic will keep your bike purring like a kitten while your sponsor's there to provide prize money so you can buy the parts to make it happen. Now all you've gotta do is ride like the devil and win. You'll face seven rivals in all.

The arcade version is pure racing for the thrill of victory. You'll cover four continents in all trying to beat the clock and advance to another stage of play. If the clock beats you, the game's over. Luckily, there's different levels of skill, so start out easy and watch your progress as you go along. The only thing between you and the winner's circle is time.

Take Control

Before you begin playing, learn which buttons prompt the moves and functions you'll rely on during play.

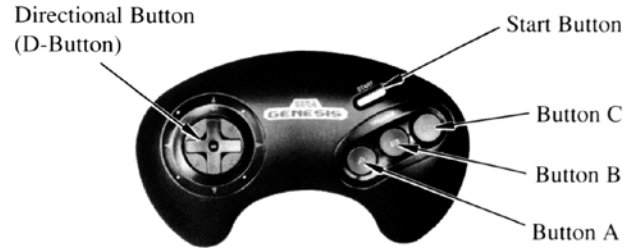

Directional Button (D-Button):

- Guides motorcycle to the left and right
- Moves selection arrow; highlights selections

Start Button:

- Starts play
- Selects options
- Pauses and resumes play once racing has started

Button A:

- Brakes

Button B:

- Accelerates up to 280 km/h
- Cancel options

Button C:

- Turbo: together with Button B accelerates over 300 km/h
- Selects options



Game Play Selection

Press the Start Button during the Title Screen to view the Game Select screen. Here you can choose from two headings: New Game or Password. To choose either heading, use the D-Button to make your selection and press either the Start Button or Button C. If you've chosen "New Game," your options are to choose between Arcade Mode or Original Mode. To choose either of the two, use the D-Button to move the arrow to your desired selection and press the Start Button or Button C.

Although there exist two types of road races, the winning strategy for both games is to ride hard, fast and accurately. One false move will dump your bike and cost you precious time and points. So stay alert and keep both eyes on the road if you want the coveted checkered flag to be dropped in your honor. Plus this game's greatest feature is that you can tune up your bike to high performance standards during "Original Mode" and then race with it in "Arcade Mode." This is the best strategy for victory in racing across all four continents.



Motorcycle Specifications

The SGR-500(R) is a special custom motorcycle developed for the year 1990. Its most outstanding feature is its ability to be upgraded into a super outstanding machine. How you will accomplish this, depends on how well you can ride.

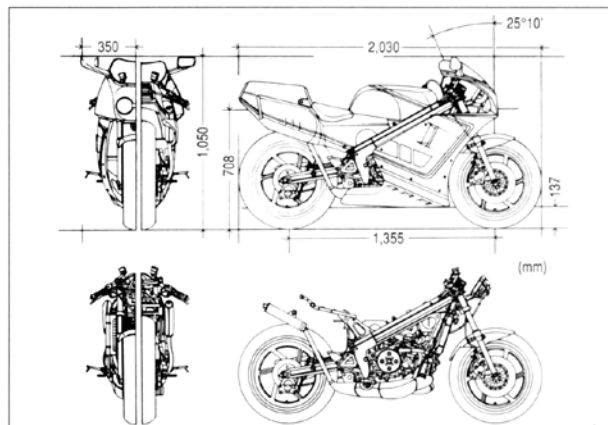

Password Screen

Before you've established a password, it's impossible to select this setting. In this case, you will want to select "New Game" first. When you finish a race in the "Original Mode," then a password will appear on the screen. Write this password down and use it the next time you play to race with the same exact machine you acquired during your previous game.



To input your password:

- Move the D-Button up, down, right and left to choose the appropriate letters. To enter, press Button C.
- If you make a mistake by choosing the incorrect letter, move the arrow to the incorrect letter while pressing Button A. Now move the D-Button to the correct letter of choice and press Button C.
- When you have finished entering your password, press the Start Button.
- If the password is correct, you will move on to the mode selection. However, if the password is incorrect, you will not be allowed to advance past the Password Screen. In this case, press the Reset Button and return once more to the Title Screen. Now you can try to re-enter your password or advance to a play mode.

Arcade Mode

During the “Arcade Mode,” you can race against time just like in the real arcade version.

The race takes place across four continents: Africa, Asia, America and Europe. There are a number of stages throughout each course, and you must complete each stage within a limited time in order to advance. However, if you do not reach the checkpoints before the time runs out, then you’re disqualified and the game ends.



Before you begin racing, a series of screens will appear with various options for your selections.

Difficulty Level Screen:

During this screen the various continents are displayed according to difficulty level. Here you must select which level/continent you’d like to race across before the time runs out. If the clock runs out, you’ll automatically race across the last flashing continent. However, to choose your own level of difficulty/continent use your D-Button to move up, down, right or left to highlight your continent of choice. Now press the Start Button or Button C. Africa represents the “Beginner” level with 6 stages of play; Asia follows with 10 stages of play at the “Junior” level; America represents “Senior” play with 14 stages and Europe represents “Expert” play with 16 stages.

Background Music:

After you’ve chosen your course, you can now select which background music you’d prefer. From the four choices on the screen, use your D-Button to sample the tunes by highlighting them. To enter your selection, press

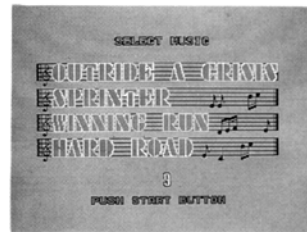

the Start Button or Button C. If you don’t make a selection before the time allowed reaches zero, then the music which is flashing will automatically be selected for play.

Start The Race:

The Start Screen will appear as soon as you’ve finished making your musical selection. The tree of lights at the starting line will flash on and off from the bottom to the

top. When the blue light flashes, this is your signal to begin the race. Press Button B to accelerate. To slow down, either release Button B or press Button A to put on the brakes and stop in a hurry. If you run off-track, your maximum speed will be decreased. And if you contact another motorcycle, you will slow down immediately.



The Race Screen:

During your race, several signals are displayed on the screen to inform you of your progress.

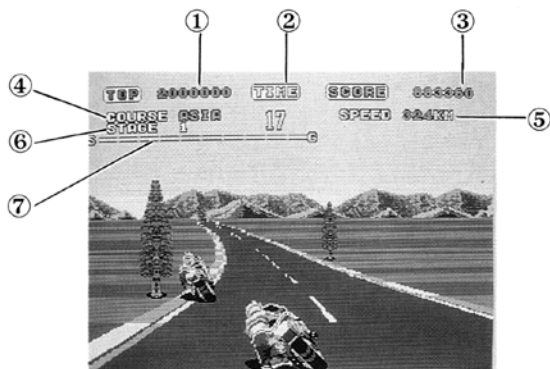

- ① In the upper left-hand corner next to “Top” will be displayed the current top score.
- ② Under the heading “Time,” your present time frame is displayed. If you do not reach the checkpoint before this figure reaches zero, then the game will end.
- ③ Next to time, your “Score” is kept simultaneously with your progress.

- ④ Next to “Course” will be displayed the name of the continent where you’re racing.
- ⑤ Your present “Speed” is indicated.
- ⑥ Beneath Course, your current “Stage” is indicated.
- ⑦ From one side of the screen to the next, a bar graph will indicate your overall position in the race by an increasing yellow gauge which begins at “S” for start and ends at “G” for goal.



The Checkpoint:

An entrance way greets you when you have reached the checkpoint. Once you pass through, you’ll automatically begin the next stage’s race. A time limit will appear immediately as well as an “Extended Play” signal which will include “Lap Time” and “Best Lap Time.” If any time remained on the clock from the previous race, it will be added to the new time limit.

End of Game:

Although we’ve said it before, this is definitely the last time you’ll hear it. If the time runs out before you’ve reached the checkpoint, then a “Game Over” message will appear.



Score:

As long as you continue to race on-track, your score will increase. However, if you race off-track or experience a collision, then your score will stop increasing. When the game ends and you've finished in seventh place or better, you may record your initials along with your ranking.

Record Your Initials:

Once you've finished the race, a score screen will appear with several players various names, rankings and scores. To enter your initials, move the D-Button left and right to choose your letters. You may choose up to three letters. A period will also count as an initial. Once you've chosen your initials, press either Button A, B or C to enter. If you've made a mistake, use the backspace arrow to delete them one at a time. Once finished, select "ED" and press Button A, B or C to return to the Title Screen.



The Original Mode

When you select the "Original Mode," play will present more options. The circuit you race on is also different. Now you'll race against opponents who appear at each level of the course and be awarded prize money according to your score. With this money, you can hire a mechanic, buy new and better parts for your motorcycle and become an even better competitor. Continue the challenge until you've beaten every opponent.

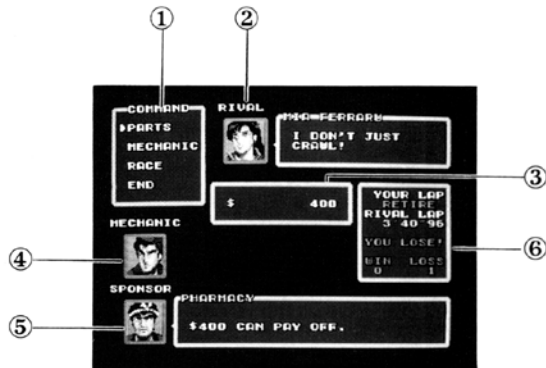

Information Screen:

When the Title Screen appears, select "Original Mode" with your D-Button and press either the Start Button or Button C. Now you'll be presented with an Information Screen which offers among other things a "Command Menu" for additional options. First, let's look at the Information Screen.

- ① In the upper left-hand corner is displayed the "Command Menu." Here you're offered options on Parts, Mechanic, Race and End.
- ② Next to this menu, you'll see an image of your rival. A window next to this will display a message from him to you.
- ③ In the window directly center, the amount of money you currently have will be displayed.
- ④ Left center displays an image of your mechanic.
- ⑤ Below his image, is an image of your sponsor. A window to the right of his image displays a message from him to you.
- ⑥ A small window to the right displays your lap time, your opponent's lap time and your number of wins and losses.

To receive the information from these windows or to select from the Command Menu, use your D-Button to scan your selections. When you've highlighted a window, press Button C to receive the information.



Command Menu:

Once you've entered the Command Menu, you must choose which option you'd like to select from. To select, use your D-Button to highlight your option of choice, then press Button C.

Parts:

When you select "Parts," the Parts Screen will appear. Here you can replace your worn parts with new, high performance parts to race more efficiently. But parts cost money, so keep in mind, you can only spend what you've earned. Plus, how you've raced will give you a good indication of what new parts you really need.

When you experience a fall on your motorcycle the frame, brakes and muffler receive considerable damage. Your engine will be damaged only slightly. Collide with another motorcycle and your frame and muffler will be slightly damaged. However, even if you make it through the entire course without any accidents, almost all of your parts are subject to wear and tear.

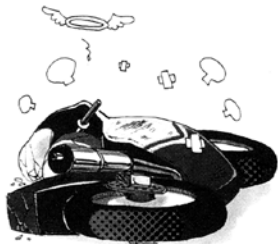

When your muffler is damaged, your ability to accelerate is reduced. Naturally, when your brakes are damaged, your ability to stop quickly is reduced. The frame, engine, oil and tires, if damaged severely will cause you to quit the race.

In the event that your frame is damaged severely and you do not have enough money to buy a new frame, you can still make an appearance on the course. As soon as you approach the starting line, you will have to quit; however, you will be awarded a small amount of prize money. So if you repeat this procedure several times, you will eventually have saved enough prize money to buy a new frame and continue racing.

The Parts Screen:

The Parts Screen will display among other things, a motorcycle illustrated with white and yellow rectangles. The parts you are presently using are surrounded by a yellow rectangle. The parts you have yet to use are surrounded by a white rectangle. Refer to your mechanic's message before you enter the Parts Screen, so you'll know exactly what the condition of your parts are before you go shopping.

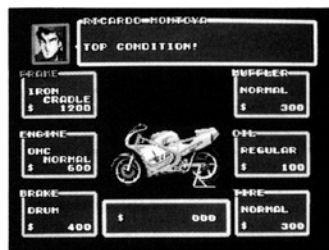

A look at the parts will reveal a dollar amount. Each part has a limit as to how much you can spend: Frame \$8,000,000., Engine \$8,192,000., Brake \$90,000., Muffler \$90,000., Oil \$14,000., and Tire \$24,000.

To buy new parts, scan the parts selection with your D-Button. When you've highlighted your part of choice, press the D-Button to the right to increase their value up to your personal limit of spending. Pressing the D-Button to the left will decrease the value if you accidentally go over your budget. Notice the rectangles on the bike will flash and change as you scan different parts selection. This will help remind you what you're shopping for. When you're ready to enter a selection, press Button C. To return to the Command Menu, press Button B.

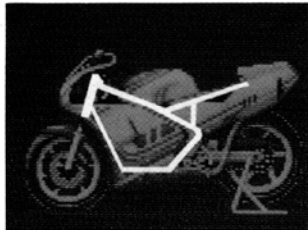

Frame:

If you replace your present frame with a better one, you will be able to turn more quickly to the right and left.

- Iron Cradle: An iron frame that is wrapped

around your engine from top to bottom. They are extremely heavy.

- Double Cradle: The two arms of an iron frame that is wrapped around the front of your engine. They are resistant to twisting and have become more reliable although they are heavy also.
- Aluminum Double Cradle: This double cradle frame is made of aluminum and so it is much lighter. However, it bends easily under pressure.
- Aluminum Space Frame: This new type of frame is divided into two halves; in front of and behind the engine. It is extremely expensive.
- Titanium Space Frame: Patterned after the aluminum space, this frame is developed from titanium alloy. Expensive but light and durable.
- Titanium Monocoque Frame: Constructed from sheets of titanium, this is the ultimate frame to own.

Engine:

The engine is the soul of the motorcycle. Be good to it and it will be good to you.

- OHC Normal: OHC stands for overhead camshaft, and was developed for use in high revolution engines.
- DOHC Normal: Two overhead camshafts are used in this system. The mechanism is more complicated and so maintenance is more difficult.
- DOHC V-4: This type of engine is often used in racing motorcycles in the 500cc class. The cylinders are arranged in a V-pattern with two cylinders in the front and back. Engine width is reduced this way.
- Turbo V-4: A turbo charger which sends pressurized air to the engine was added to the DOHC V-4 engine. When you begin to hit speeds over 280 km/h, the acceleration is explosive.
- Ceramic Turbo: This ceramic turbo engine is light and wear resistant. Even with current advantages in technology, it is not easy to make this engine.
- Twin Turbo: An engine with more power than any of the above. This engine maxes out with two turbo chargers on board a ceramic engine. However, high performance does have its costs. This baby is tough to take care of.

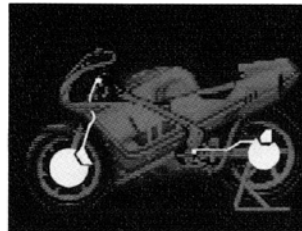
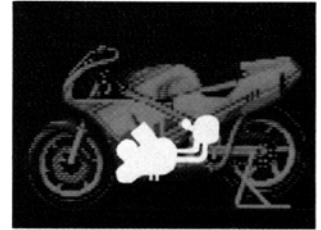

Brakes:

The distance required to stop and the effects of moisture on the brakes will vary according to how superior your brakes are.

- **Drum Brakes:** Drum brakes use an abrasive on a rotating drum to drive the brakes. This system heats up and is hard to cool down.
- **Disc Brakes:** A disc brake mechanism uses a round disc which clamps on both sides of the wheel to stop it from turning. This system is heat resistant and well suited for high speed racing.
- **Ventilated Disc Brakes:** A more improved version of disc brakes. Holes are provided in the discs so they cool down even faster. Very steady braking is the result although these brakes carry a hefty price tag.
- **Double Disc Brakes:** Just like the name implies, two discs are used in this brake system for double the efficiency.
- **Anti-skid Brakes:** Using the latest technology, this brake system prevents tire lock and sideways skidding which typically accompanies sudden braking.

Muffler:

The muffler acts to efficiently rid the engine of exhaust. The better the muffler, the quicker the acceleration.

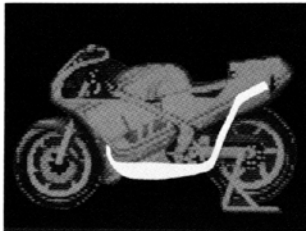

- **Normal Muffler:** Apart from being inexpensive, this muffler has no outstanding features.
- **Cool Muffler:** This muffler collects the exhaust gases into one mass before discharging them.
- **Works Original:** An original; and based on its efficiency, practically a work of art.
- **Private Original:** This is constructed privately to suit your individual machine – and you can bet it costs a fortune.

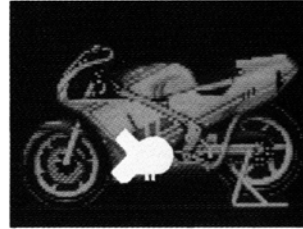

Oil:

Oil helps the engine to run more smoothly. Naturally, the better oil will increase acceleration and reduce the burden on the engine.

- **Regular Oil:** No big deal.
- **Manual Oil:** Developed by one manufacturer to represent the standard for all oils.
- **Top Oil:** A special additive was incorporated into this oil to improve performance.
- **Private Original:** Highly heat resistant, it is perfectly suited to high speed acceleration and designed just for your machine.

Tires:

Tires wear out the fastest on a motorcycle losing their lifesaving road hugging grip.

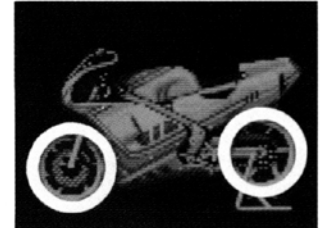

- **Normal Tires:** Mediocre performance, replacing these tires should be one of the first investments you make.
- **Radial Tires:** By reducing engine power loss, these tires grip the road firmly.
- **High Performance Tires:** Top class sport tires with sheer will to grip the road.
- **Slick Tires:** Developed expressly for racing, these tires will never let go.
- **Original Slick Tires:** Made by special order, these tires are a perfect fit for your motorcycle and riding style since they're designed expressly for you.

Mechanic:

When you've acquired enough money to hire a mechanic select this option from the Command Menu. The more he is paid, the better his results are in these areas: mechanical skills, longevity of your parts, and reliability of advice.



To Hire: Move the D-Button to the left or right to review mechanic choices. Confirm your selection by pressing the Start Button or Button C. Press Button B to return to the Command Menu.

Race:

When you choose "Race" from the Command Menu, the "Select Music" Screen will appear. Here you can choose from the four musical selections by pressing the Start Button or Button C. Now the Start Screen will appear.

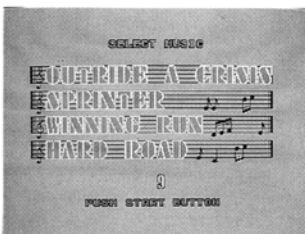

End:

If you'd like to stop play and resume later, select "End" from the Command Menu. On the same screen a password will appear. Write it down and enter it the next time you play by selecting "Password" from the Main Menu. The race will begin from your last success-

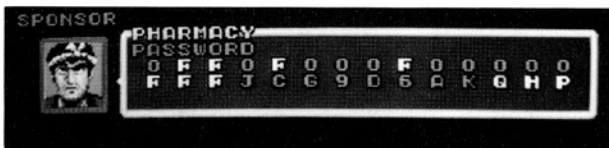

ful level. Before you turn off the game, press Button C or the Start Button to return to the Title Screen.

The Outcome:

If you're able to record five victories before your opponent does, you'll advance one rank and receive a more generous sponsor. You'll also compete against a new and more challenging rival. If you record five losses before your opponent does, then you will drop a rank and receive no new benefits. If you're at the lowest level, nothing will change.

Start The Game:

After you've selected your music, the Start Screen will appear. When the blue signal begins to flash, it's time to start.

Distance: The Lap Time at the very beginning of the race covers the distance from the starting line to the checkpoint. However, after the first checkpoint, the Lap Time will cover the distance from one checkpoint to the next. When the race ends, a window will appear with your results.



Meet Your Maker

Your Opponents

Each rival is a worthy competitor. Here you'll read their names and backgrounds to prepare yourself for on-screen competition.

Mia Ferraru

– 23 years old, Italy:
Mia's invincible riding style has earned her the nickname, "Rocket Girl." She's a definite speed demon with a passion for racing. Although she's just a girl, she's better than most of her male counterparts.



Jose Alvarez

– 24 years old, Spain:
The Latin blood in Jose makes him a courageous but crazy rider. He's known for extreme rash moves on the course which gives everyone something to worry about. Should he ever curb his recklessness, he may become a brilliant racer.



Nobuhiko Hasegawa

– 21 years old, Japan:
Finishing near the top in the world's most challenging races, Nobuhiko promises to be a major figure on the circuit. He is a poised racer.



Felica Perez

– 25 years old, Mexico:
Felica has the heart of a lion and the courage to match. She is unmatched on the circuit for dynamic cornering and precision timing. She is loved by both fans and racers alike.



Hans Braun

– 35 years old, Germany:
Racing with flawless expertise, Hans enjoys the coordination of a high precision machine. This racing style has earned him the nickname, "The Ice Man," which gives great fear to his opponents.



Marie Lefoure

– 18 years old, France:
Petite and genuine, Marie is the idol of all racers alike. She is quick, coordinated and fearless. At such a young age, she has mastered courses other racers have had to wait until their mid-20's to overcome.



King Arthur

- 30 years old, Great Britain:
To earn such a nickname,
one must be a world cham-
pion which Arthur is.
He has set countless
records, won all the major
titles and rides with a bold
and graceful style. He is the
best racer alive. You should
definitely set your sights on
him.



Appliance Store Owner:
In order to generate
publicity for her store,
this sponsor picks only
the best racers sight
unseen.

Toy Company Owner:

With a newly designed
race simulator, this sponsor
is out to make his racers
the best.



The Sponsors

The sponsors come from all walks of life; what draws
them together is their shared enthusiasm for motorcycle
racing.

Pharmacist:

The pharmacist is a
good and reliable
sponsor, his only re-
quirement is that you
wear an advertisement
for his store on your
bike.



Distributor:

With millions in eggs,
this sponsor is extremely
generous and good to
have around.



Pizza Chain Owner:

A ruthless sponsor, he'll
throw stones at his
opponents' motorcycles
and into their pit stops.
His dream is to come in
first at World Grand Prix.

Bike Manufacturer:

His goal is to manufacture
motorcycles, so he is a wise
and understanding sponsor.
Plus he's not hurting for
cash either.





Oil Company President:
Giving away the top prize money, this woman has earned a reputation for cruelty. She will toss a racer out the moment he's showing signs of failure.

Koutaro Kita
– 21 years old:
After studying engineering in college, Koutaro found the theory of motorcycle maintenance a noble and fascinating study. He is a most intellectual mechanic.



Mechanics

Since motorcycle parts suffer wear and tear in every race, a good mechanic is essential to a winning performance. Here's a look at some of your options.

Ricardo Montoya
– 17 years old:
Ricardo is an ex-racer, long on criticism of other racers, short on experience. He has yet to become a great mechanic.



Takeshi Onda
– 53 years old:
With 35 years of experience, Takeshi is a true veteran mechanic. A good father figure, this one doesn't mince his words.

Tom Jones
– 24 years old:
A Californian with a good disposition for motorcycle maintenance and racing. And as Californians go, he's a real charmer.



Miki Aisawa
– 18 years old:
Since her childhood, Miki has loved motorcycles. By rebuilding abandoned bikes, she has acquired a hands-on knowledge of the machine that is invaluable.



Sonny Illvich
– 27 years old:
Moved to the West to practice her incredible skills and become a first class mechanic.

Mickey Wei
 – 48 years old:
 After suffering an injury following an illustrious racing record, Mickey switched to the mechanic's side where he's led many competitors to victory.



Handling The Sega Genesis Cartridge

- The Sega Genesis Cartridge is intended exclusively for the Sega Genesis System™.
- Do not bend, crush or submerge in liquids.
- Do not leave in direct sunlight or near a radiator or other source of heat.

Helpful Hints

The best advice we can give you now is to stay alert, hang tough and ride like the wind if you want to cross that finish line before anyone else. Remember it's not over till it's over.



Scorebook

| | | | |
|-------|--|--|--|
| Date | | | |
| Name | | | |
| Score | | | |

| | | | |
|-------|--|--|--|
| Date | | | |
| Name | | | |
| Score | | | |

©SEGA